

Quantum Linear Tile Insert - 60mm x 900mm

Product Images

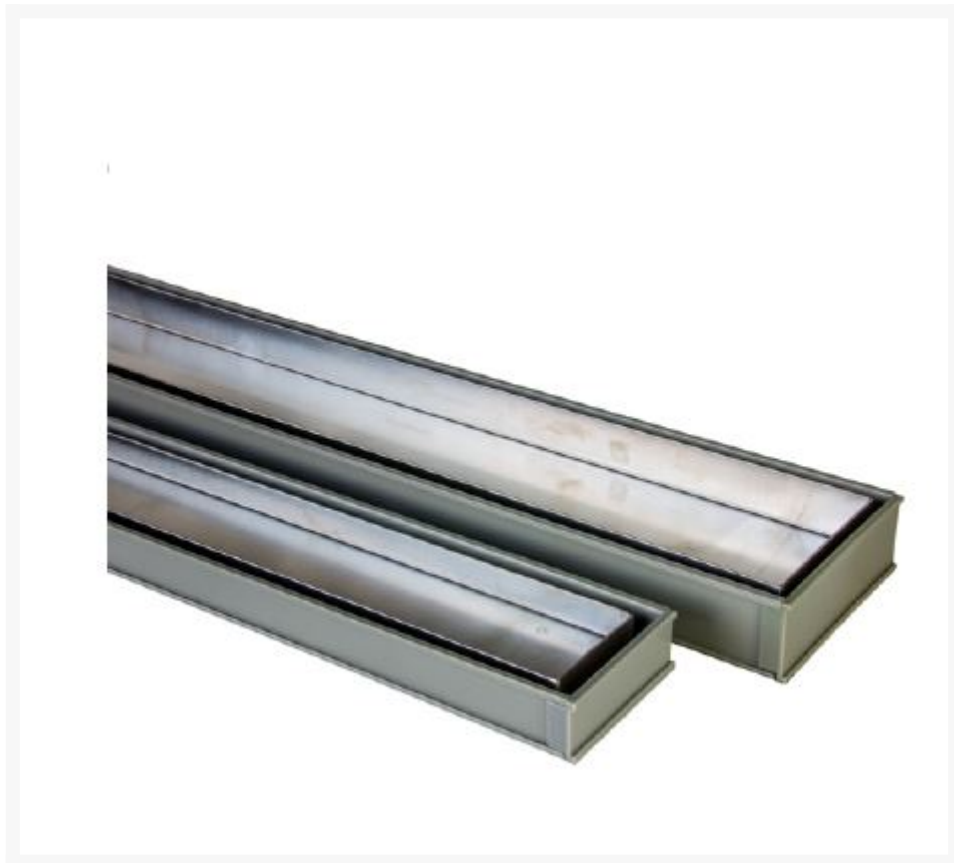

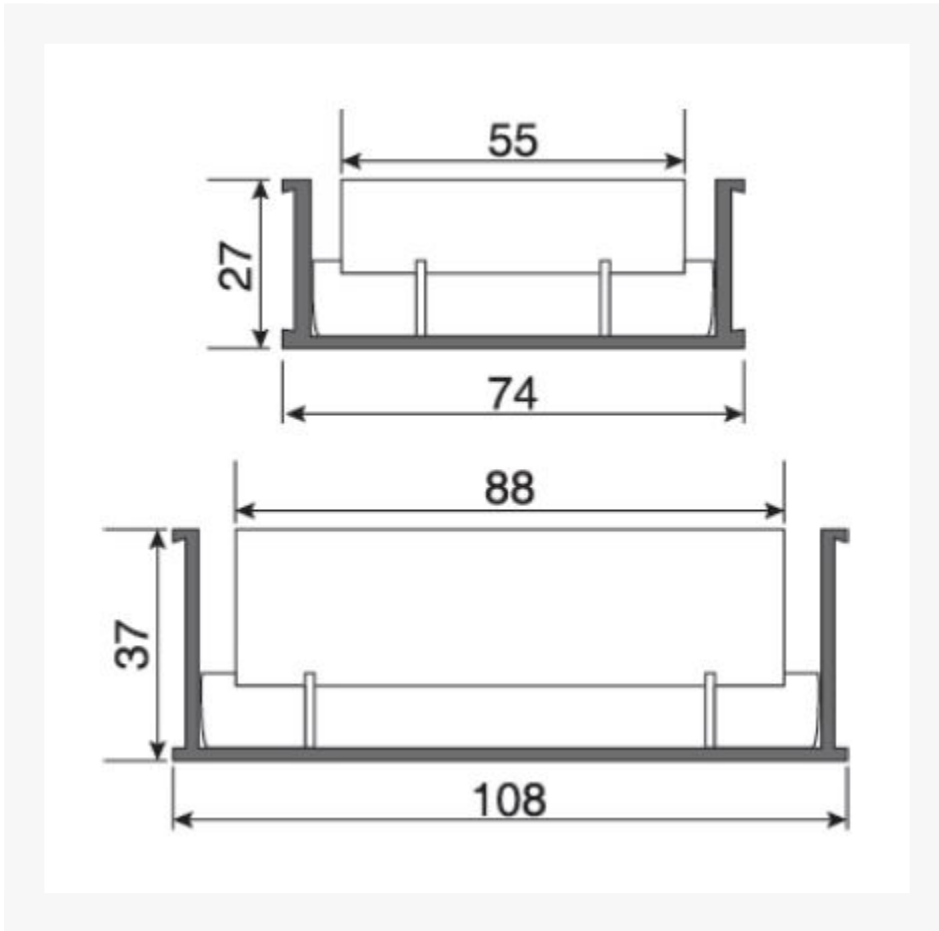

Short Description

Quantum Linear Tile Insert - 60mm x 900mm

Description

Quantum Linear Tile Insert - 60mm x 900mm

World Class Performance and Design

Hydro Construction Products specializes in providing modern and effective drainage solutions. We provide unrivaled service, so you get the drainage solution you need.

We are proud to present our Hydro Performer Series of traditional square style floor wastes and linear drainage systems, available with stainless steel or uPVC channels and accessories.

Features:

This high-performance, cost-effective range features architectural wedgewire grating and tile inserts which will blend seamlessly with your floor surface.

The Hydro Performer Series product range conforms with WaterMark Levels 1 & 2. Hydro Construction

Products is a member of the Australian Stainless Steel Development Association (ASSDA) for true quality assurance.

Applications:

- Bathrooms & Showers
- Swimming Pools
- Courtyard & Patio
- Residential
- Sports & Leisure Facilities
- Wet Areas
- Hotels, Restaurants & Cafes
- Commercial Kitchens

Additional Information

CODE	ACP-TL60PL-900
U.O.M	Each
Weight	250
Swatch	no_selection

